

Bitsman Auto Tire Mobility Kit



User Manual

Thank you for using the tire mobility kit series products. Please store it carefully after reading this manual for future reference. The picture is for reference only, actual product may vary.

I. Product description



① Sealant Bottom

② Sealant Body

③ Sealant Cap

④ Sealant Hose

⑤ Power Cord

⑥ Cigarette Lighter

⑦ Inflation Hose

⑧ Copper nut

⑨ Inflator

⑩ On-off

⑪ Label

II. User manual

(i). Tire repair operation method



1. Make sure the on-off button is off. Loosen the sealant hose on the tire sealant bottle and the inflation hose on the inflator, connect the inflation hose to the air inlet of the sealant body, and then align the tire sealant bottle interface with inflator and push it in horizontally.

2. Connect the sealant hose onto the tire valve.

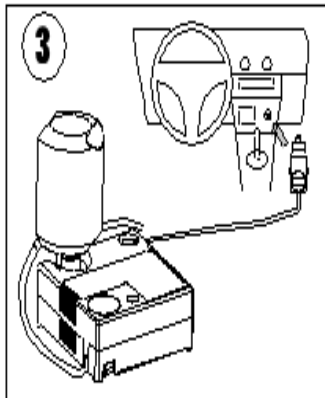
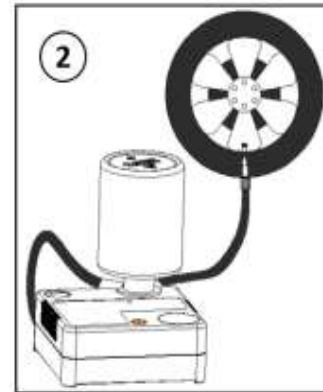

3. Insert the cigarette lighter into the car power socket, then start the car engine.

4. Turn on the on-off button (black) to inject tire sealant. At this moment, the pressure value will first rise to about 400kPa, and then slowly decrease to the flat tire pressure (80-150kPa). When the tire pressure reaches the recommended value (220-250kPa), turn off the on-off button, and then take out the sealant hose, inflation hose, and cigarette lighter.

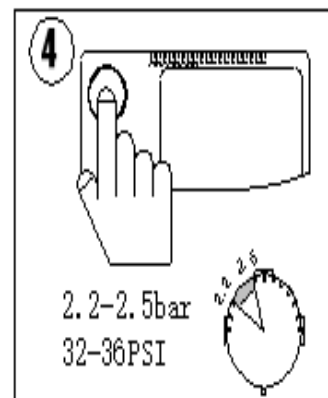

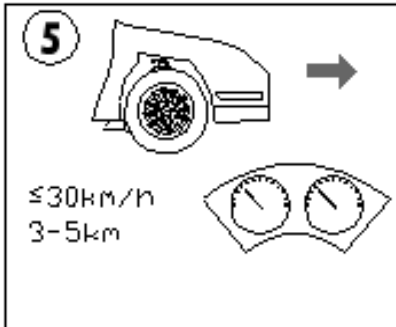

5. Restart the vehicle and drive the vehicle at a speed of less than 30km/h for 3-5km.

6. Park the vehicle in a safe area and connect the inflation hose to the tire again.

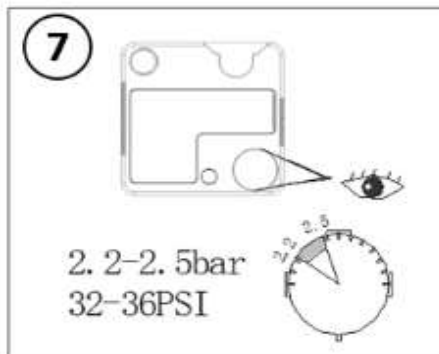
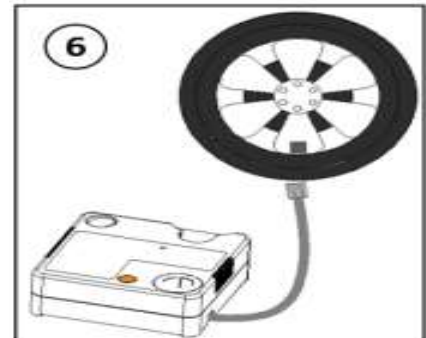

7. Observe the air pressure gauge, if the air pressure is lower than 180kPa, perform the inflation operation, then drive for 3-5km and check the tire pressure. If the tire pressure still drops significantly, it means that the tire is seriously damaged, which is beyond the scope of repair by the product. Which in this case, you will need to go to a car repair shop for instant assistance. If not, which means the tire is perfectly gets fixed.

8. After repair was completed, please drive at a speed less than 80km/h.



(ii). Tire pressure detection operation method

1.Take out the inflation hose and gauge to connect it to the tire valve.

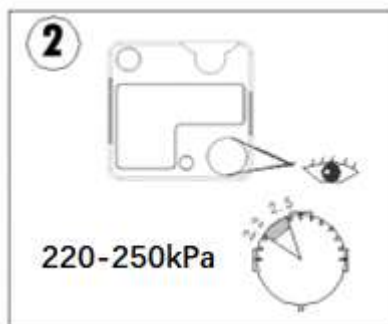
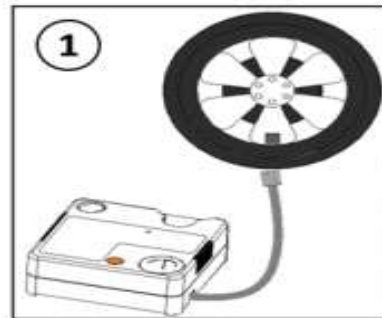

2.Observe the air pressure measure the tire pressure.

(iii). Tire inflation operation method

1.Take out the inflation hose and connect it to the tire valve.

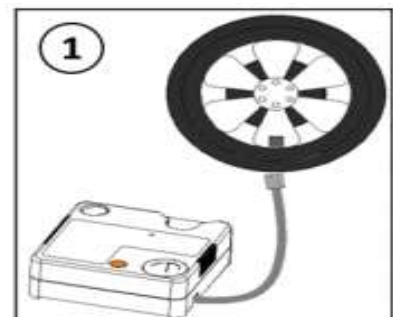

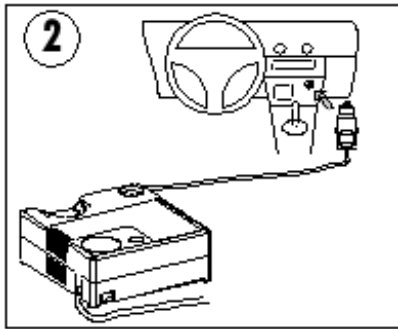

2. Insert the cigarette lighter into the car power socket, then start the car engine.

3. Turn on the on-off button (black) to inflate the tire, observe the air pressure gauge, turn off the on-off button when the tire pressure reaches the manufacturer's guide value (or 220-250kPa), and pull out the inflation hose and cigarette lighter.

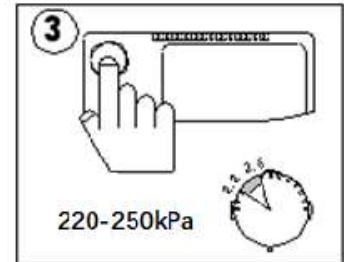

(iv). Tire pressure-relief operation method

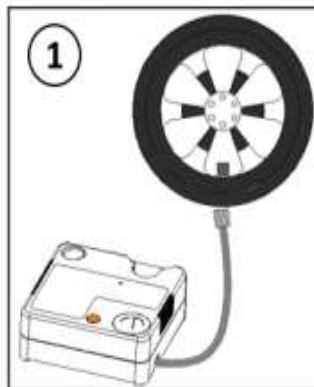

1. Take out the inflation hose and connect it to the tire.

2. Press the pressure relief valve button (yellow) and observe the air pressure gauge until the tire pressure reduce to the desired value.

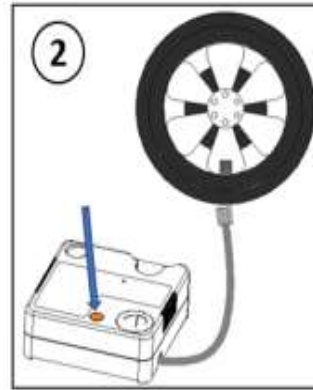

III. Specifications

Product Specification

Product name	Bitsman Tire Mobility Kit
Model number	KIT450/300
Product size	250mm*150mm*90mm
Length of power cord	3060mm±50mm
Tire filler capacity	300ml/450ml
Applicable tire sizes	See next table
Storage temperature range	-30 ~ 70°C
Operating temperature range	-30 ~ 70°C
Operating voltage	DC9 ~ 16 V
Power	≤ 120 W
Steady state current	≤ 15A
Safety valve relief pressure	5±0.5bar
Length of air hose	≥550mm
Length of sealant hose	≥500mm

Volume & Tire Size Cross Reference Table

300ml tire sealant		
Tire width (mm)	Flat ratio (%)	Tire diameter (inches)
175mm	60%~70%	13in
165mm	70%	14in
175mm	60%~70%	14in
185mm	60%~65%	14in
165mm	60%	15in
175mm	55%~60%	15in
450ml tire sealant		
Tire width (mm)	Flat ratio (%)	Tire diameter (inches)
215mm	65%~75%	15in
225mm	60%~75%	15in
215mm	60%~70%	16in
225mm	50%~75%	16in
235mm	60%	16in
215mm	55%~70%	17in
225mm	45%~65%	17in
235mm	45%~60%	17in
245mm	40%~50%	17in
255mm	40%	17in
215mm	55%	18in
225mm	40%~60%	18in
235mm	40%~55%	18in
245mm	35%~45%	18in
255mm	35%	18in

Egoldvan Industry Co., Limited

Cell/Wechat/Whatsapp: +86 15900974134, sales@bitsmanauto.com,

Factory Address: Building 2, No. 2008, Diamond Road, Weitang Town, Xiangcheng District, Suzhou City, Jiangsu Province, +86 0512-66152800

225mm	35%~55%	19in
235mm	35%~45%	19in
245mm	30%~40%	19in
255mm	30%	19in
235mm	35%	20in

IV. Quality assurance

1.1 We promise that the tire mobility kit we sell are of high quality and are manufactured and sold in accordance with the relevant standards.

1.2 Although all reasonable measures are taken to ensure the quality of our products, the service life and performance of tire mobility kits are affected by a number of factors including, but not limited to, road conditions, usage patterns and maintenance.

1.3 We are not responsible for the suitability of the tire mobility kit for a particular purpose and for any damage arising therefrom.

1.4 The manufacturer or seller of a tire mobility kit will not be responsible for any damage or injury caused by the kit being incompatible with a particular vehicle make or model. Before purchasing a kit, please ensure that it is compatible with the make and model of your vehicle and follow the installation and use instructions provided by the manufacturer. If you have any questions about compatibility, please consult a professional automotive technician or contact our customer service team for assistance.

V. Product features

About the tire mobility kit:

This product features a new powertrain with three main functions:

- **Check at any time:** It comes with a high-precision air pressure gauge, so you can check the tire pressure at any time.
- **Rapid inflation:** The self-inflation inflator allows for a rapid inflation of the tires when the air pressure is below the rated value.

- **One-touch pressure relief:** If the tire pressure is too high, press the pressure relief switch (yellow) to lower the tire pressure to the standard range, and the pressure can be easily relieved with one touch.

When the inflator is used in conjunction with the tire filler can, the tire can be filled with tire filler and inflated automatically without removing the valve core.

About the tire sealant:

The tire sealant used in this product has several characteristics:

- **No damage:** The patching rubber is made of natural rubber, the same raw material as the tire, and does not cause any damage to the tire.
- **Non-corrosive:** The tire sealant is weakly alkaline and does not corrode the aluminium rim of the wheel.
- **Easy to clean:** The tire sealant is water-soluble and can be cleaned by gently wiping with a soft cloth with water.
- **Non-flammable:** Tire sealant is a non-flammable liquid and meets international transportation safety regulations.
- **Wide range:** The tire sealant maintains its sealant properties in the ambient temperature range of -40°C to 80°C.
- **More environmentally friendly:** The sealant formula is safe and meets all environmental requirements.

VI. Exception Clause

➤ **Suggestions for use**

2.1 We recommend that the customer read the manufacturer's instruction manual, installation instructions and precautions in detail before installing and using the tire mobility kit and that he follows its provisions correctly.

2.2 We shall not be liable for any accidents, losses or damages resulting from the customer's failure to comply with the user manual or installation instructions.

2.3 Because the sealant is a mixture of different molecular structures, it cannot be kept still without shaking for more than 6 months from the time of picking up the goods at the port. More than 6 months will cause the sealant to fail which is not covered by our warranty.

2.4 When the air pressure exceeds 2.5bar, the inflation time may need to be appropriately extended.

➤ **Installation and maintenance**

3.1 The installation of the tire mobility kit should be carried out by a specialist technician and in accordance with the manufacturer's instructions.

3.2 We are not liable for accidents, loss or damage caused by the customer's failure to properly fit, maintain or regularly inspect the tires.

3.3 Any modifications to the kit not authorized and directed by the manufacturer or seller of the tire mobility kit will invalidate the warranty and the manufacturer or seller will not be liable for damage, injury or loss caused by such modifications. Any modifications should be carried out under the express instructions of the manufacturer or seller and in accordance with the relevant laws and regulations.

3.4 Our sealant is designed for storage in temperatures ranging from -40°C to 80°C, and it is intended to operate within the temperature range of -10°C to 70°C. When the temperature exceeds 30°C, it is recommended to drive for a distance of 20 kilometers or more after conducting any necessary repairs.

➤ **Road conditions and usage environment**

4.1 Tire performance is influenced by a variety of factors such as road conditions, climate and the environment in which they are used.

4.2 We are not responsible for any accidents, loss or damage caused by tires in poor road conditions, extreme weather or unsuitable use.

4.3 The manufacturer or seller of the tire mobility kit will not be liable for any delay, failure, damage or failure to perform its obligations as a result of force majeure. Force majeure factors include, but are not limited to, natural disasters (e.g. earthquakes, floods, storms), war, acts of terrorism, strikes, interruptions in the supply chain, governmental acts or changes in laws and regulations.

➤ **Product information**

5.1 Every effort is made to provide accurate product information, including but not limited to dimensions, load indices and speed levels.

5.2 The Customer should check the information on the products required carefully before purchasing and ensure for himself that they are suitable for the purpose for which they are required.

5.3 We shall not be liable for any accident, loss or damage caused by the customer's failure to check the product information correctly.



➤ **Other**

6.1 We shall not be liable for any accident, loss or damage arising from the use or inability to use the tire mobility kit sold.

6.2 The manufacturer or seller of a tire mobility kit is not liable for any consequential, incidental, punitive or special damages arising out of the use or inability to use the kit. The manufacturer or seller shall not be liable whether in contract, tort (including negligence) or other legal theory, including but not limited to lost profits, revenue, business, data, goodwill or other intangible losses.

VII. About us

Company name	EGOLDVAN INDUSTRY CO.,LIMITED
Company Address	No. 2008 Diamond Road, Weitang Town, Xiangcheng District, SuzhouCN 215134
Zip code	215134
Service calls	+86 15900974134
Service Email	sales@bitsmanauto.com
You Tube	https://www.youtube.com/@BITSMANAUTO
Facebook	https://www.facebook.com/bitsmanauto
Linkedin	https://www.linkedin.com/company/bitsmanauto/
Twitter	https://twitter.com/BitsmanA18202
Instagram	https://www.instagram.com/bitsmanauto/
Pinterest	www.pinterest.co.uk/bitsmanauto/
WeChat Public 	

<p><u>User Guide Media</u> <i>Scan</i> <i>learn how to use!</i></p> 	
<p>WeChat</p> 